

# Product Range



the AESSEAL® group of companies

designers and manufacturers of mechanical seals, bearing protectors, seal support systems and gland packing which maximize rotating equipment up-time.

## Customer Service

Customers buy from AESSEAL® not just because of our superb products but because of our exceptional performance; 98.7% on-time delivery:

- One global delivery performance standard
- In our industry, inventory = service. AESSEAL® holds inventory so customers don't need to
- With up to six months stock we can guarantee exceptional delivery performance and give our customers exceptional turnaround times, saving you time and money
- A modular product range, with over 10 million permutations, ensures AESSEAL® can supply the right solution for your application, where you want it, when you want it

### Does your existing supplier offer you unconditional product and service guarantees?

As part of a seal management program, AESSEAL® provides the following unconditional guarantees:

- Any standard product not shipped within 48 hours will be provided free of charge
- 'No work, no pay' warranty
- We guarantee to seal your plant at 25% less cost than the total charge of your current suppliers

















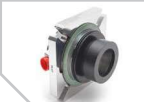

Seamless integration of CAD / CAM and 9-axis machine tools

“**Custom-engineered products** account for over 56% of our business and we have the design and manufacturing infrastructure to deliver them **fast.**”

## Contents

This brochure provides a brief overview of our extensive inventoried product range.

 Component Seals for Pumps 5	 Oil, Gas and Petrochemical Seals 16
 Cartridge Seals for Pumps 6	 High Pressure Seals 17
 Cartridge Seals for Progressive Cavity Pumps 10	 Gas Seals 18
 Non-Metallic Seals for Chemical Pumps 10	 Industry Specific Designs 20
 Radially Divided Seals 11	 Bearing Protectors 22
 Submersible Pump Seals 11	 Gland Packing 23
 Metal Bellows Seals 12	 Seal Support Systems 24
 Seals for Mixers, Agitators and Reactors 13	 Company Overview 26

“Over 10 million inventoried standard product permutations **plus** custom-engineered solutions.”

## Global

Customer service is provided from 230 locations in 104 countries, including 9 manufacturing and 58 repair locations, with more than 300 customer service representatives who visit industrial plants every day.

Don't take our word for it...

### Portugal

"Late Friday is not a great time to identify a serious seal problem. But AESSEAL immediately got down to us and worked through the issues. They're now consulting for us on other plant equipment, improving MTBF. A real full service partner!"

### Italy

"Our previous supplier indicated that it was impossible to better two months' performance on an application. AESSEAL implemented a solution that has been running for over 15 months without problems and are now a key supplier for the entire plant."

### Germany

"I was delighted by the way the engineer at AESSEAL reacted so fast to a broken bearing housing problem. It happened at 08:00hrs on a Sunday, and he measured up, opened up their workshop and we were running again on the Monday. AESSEAL jump immediately... Great service."

### Turkey

"The frequency of shaft packing damage was a problem in the lime progressive pump section. At AESSEAL they invested time to provide a technical solution in planning and on site installation. Before long they became our preferred seal supplier."



### USA

"AESSEAL's ownership in the equipment is exceptional, as is its communication system. Our failure rate and reliability risks from seal failures have steadily declined. They provide maintenance and reliability with valuable information on the MTBF of the equipment."

### South Africa

"At our Glucose refinery we are not customers of AESSEAL but partners. With our input and AESSEAL's technical skills and reliable service, problem mechanical seals are a thing of the past."

### Malaysia

"We in KTSB believe AESSEAL is reliable, dependable and above all a company that conducts its business with a high level of integrity."

### Australia

"A heavy-duty dual slurry seal is not easy to find over the Christmas period – but the AESSEAL guys gave up their public holiday to build one from scratch. They are always available to me, a great facility."

AESSEAL® is delighted to support WaterAid's vision of a world where everyone has access to safe water and sanitation. [www.wateraid.org](http://www.wateraid.org)

 WaterAid

Charity registration number 288701

## Component Seals

AESSEAL® has a comprehensive range of component seals for all applications. Some of the more popular designs are shown below.

### SAI™ — Internal Balanced Mechanical Seal



- Non-shaft-fretting design to reduce cost of equipment overhaul
- Maximizes seal life in suspensions and liquids such as slurries given the smooth non-clogging profile (springs out of the product)
- Hydraulically balanced seal-face
- Premium drive integrity (milled metallic lug drive)
- Sizes available from 0.750" to 6.000" (18mm - 155mm)

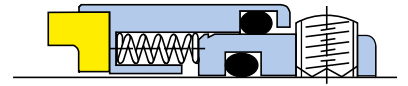

### M0 series — Internal Monolithic Face Mechanical Seal



- Available with a hydraulically balanced or unbalanced seal-face
- Non-clipped, multiple spring design
- PTFE wedge or elastomer shaft seal options
- Available in 12 generic forms, covering shaft sizes 0.750" to 4.000" (20mm - 100mm)

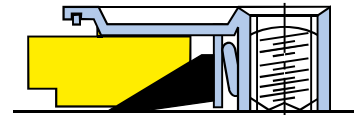

### B02™ — Internal Bellows Mounted Mechanical Seal



- Bellows with **no** bonded joints, available in Viton®, Nitrile or EPR
- Single coil spring design with bi-directional shaft rotation feature
- Available in 3 generic forms, covering shaft sizes 0.375" to 4.000" (10mm - 100mm)

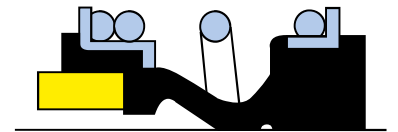

### P0 series — Internal Single Coil Spring Mechanical Seal



- One of the most commonly used component seal designs globally
- Single coil spring design with bi-directional shaft rotation feature
- Positive face drive mechanism
- Available in 9 generic forms, covering shaft sizes 0.375" to 3.000" (10mm - 75mm)

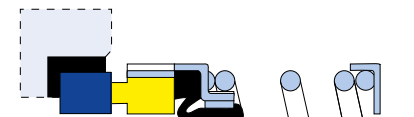

### CS™ / CSC™ Range — External Seal with Non-Metallic Parts



- External seal with hydraulically balanced seal-face
- Non-metallic wetted parts for use in chemical applications
- Supplied clipped and pre-set to working length
- Available with collet drive for use with hardened or non-metallic sleeves
- Sizes available from 0.625" to 4.000" (20mm - 100mm)

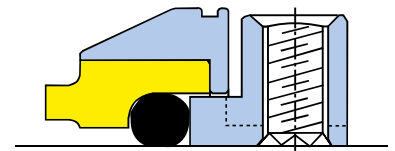

For more information please see the product literature or visit:  
[www.aesseal.com/component](http://www.aesseal.com/component)



SAICSNCESEAT



S-SPRING

# Single Cartridge Rotary Seals

All of the following feature:

- Hydraulically balanced seal-face technology for reduced power consumption
- Non-clogging rotaries and non-shaft-fretting elastomers
- Multiple spring and positive set screw shaft drive



## Converter II™ — Cartridge Seal Designed to Replace Packing

- Cartridge seal designed to replace two-part component seals and conventional packing arrangements
- Short external length
- Compact gland for use on applications with limited space
- Sizes available from 1.000" to 4.000" (24mm - 100mm)

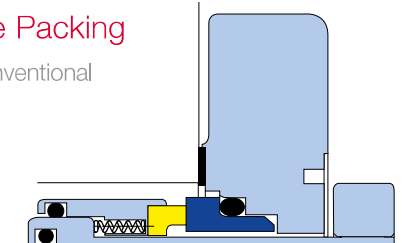

## SCUSI™ — Short Cartridge Seal

- Has Flush port as standard for cooling or venting to maximize seal life
- Self-aligning stationary face, maximizing seal life
- Stationary face with radial locating pins minimizes damage in stop / start applications and viscous fluids
- Sizes available from 1.000" to 2.750" (24mm - 70mm)

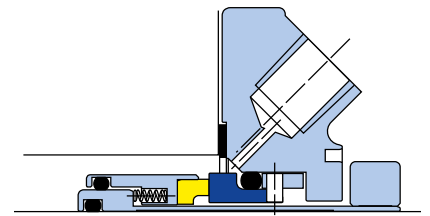

## CSSN™ and CSSN-R™ — Single Cartridge Seals

- Modular range of cartridge mechanical seals for general applications, supplied with Quench, Flush and Drain ports as standard
- Optional modular restriction bush (CSSN-R™) supports Plan 62
- Sizes available from 1.000" to 3.500" (24mm - 85mm) in standard and ANSI Plus gland formats larger sizes termed CSS™

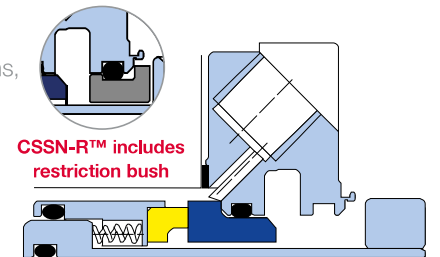

## CURC™, CRCO™ and CURE™ — Single Cartridge Seals

- Self-aligning stationary face, maximizing seal life
- Stationary face with radial locating pins minimizes damage in stop / start applications and viscous fluids
- Quench, Flush and Drain ports for cooling or heating options to maximize seal life
- Sizes available from 1.000" to 5.000" (24mm - 125mm) in standard and ANSI Plus gland formats
- Bi-metal option — Exotic Alloy wetted components for maximum versatility at minimum price premium

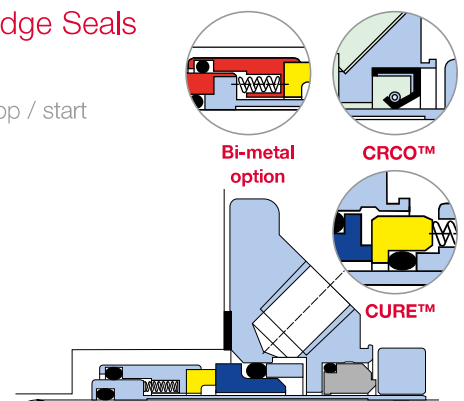

For more information please see the product literature or visit: [www.aesseal.com/single](http://www.aesseal.com/single)



CII

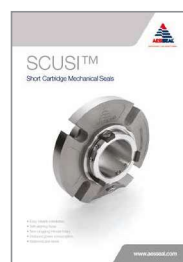

SCUSI



CSS/CDP/A



CURC

# Single Cartridge Stationary Seals

All the following feature:

- Hydraulically balanced seal-face technology for reduced power consumption
- Non-shaft-fretting sleeve elastomer and positive set screw shaft drive
- Multiple spring seal-face loading
- Stationary design is suitable for high speed applications

## SISS™ and SISR™ — Single Stationary Seals

Modular range of stationary cartridge mechanical seals for general applications in all industry sectors.

- High-integrity drive design features for improved reliability and seal life
- Supplied with Quench, Flush and Drain ports as standard
- Optional modular restriction bush (SISR™) supports Plan 62 allowing control of the seal environment, maximizing seal life
- Sizes available from 1.000" to 3.375" (24mm - 85mm) in standard and ANSI Plus gland formats

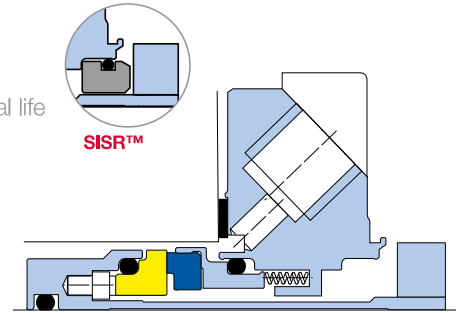

## SMSS™ — Single Monolithic Stationary Seal

A single cartridge stationary seal with modular monolithic seal-faces.

- Monolithic seal-faces provide maximum face stability in high pressure and high temperature applications improving seal life
- Seal-face drive over large contact area minimizing damage to faces in stop / start applications and viscous fluids
- Large 3/8" NPT ports maximize cooling and extend seal life
- Short inboard axial length
- Sizes available from 1.000" to 5.000" (24mm - 125mm) in standard and ANSI Plus gland formats

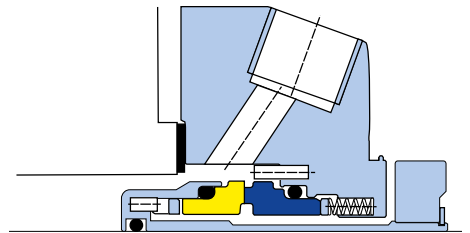

## SMSS23™ — Plan 23 Single Stationary Seal

A single cartridge stationary seal with integral Plan 23.

- Extremely effective Plan 23 with bi-directional integral pumping ring
- Ideal for boiler feed and boiler circulation duties
- Integral inboard restriction bush configuration, adapted to suit the equipment
- Total solution available including heat exchanger
- Sizes available on request. Please contact AESSEAL®

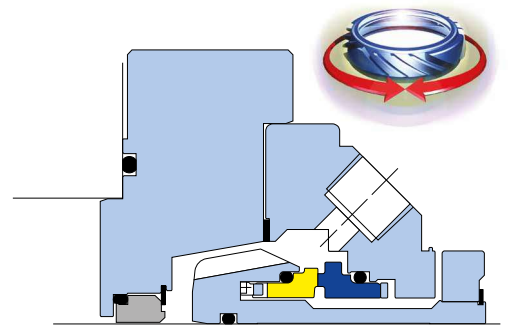

For more information please see the product literature or visit:  
[www.aesseal.com/single](http://www.aesseal.com/single)

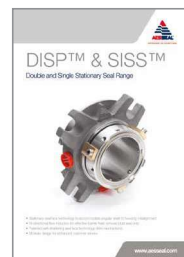

DISP&SISS

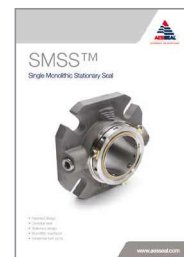

SMSS



SMSS23

## Double Cartridge Rotary Seals

All the following feature:

- Hydraulically balanced seal-face technology for reduced power consumption
- Non-shaft-fretting sleeve elastomer and positive set screw shaft drive
- Independent seal-face design to enhance safe containment of process fluid in the event of damage to any individual sealing element
- Multiple spring seal-face loading

### CDPN™ — Cartridge Double Seal

- Modular range of cartridge double mechanical seals for general applications
- Supplied with Quench, Flush and Drain ports as standard
- Sizes available from 1.000" to 3.500" (24mm - 85mm) in standard and ANSI Plus gland formats larger sizes termed CDP™

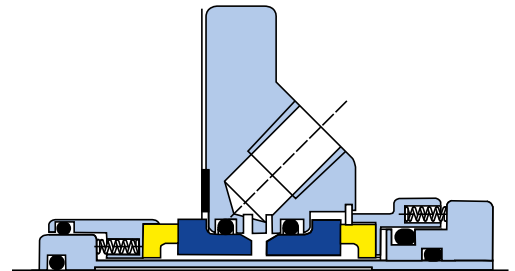

### CDSA™ — Cartridge Mounted Double Seal

- This modular seal is ideal for the containment of hazardous process fluids
- Flexible design allows use as a double seal (high pressure barrier fluid) or tandem seal (low pressure barrier fluid) which reduces the necessity to inventory two designs of seals
- Self-aligning stationary seal-faces with radial contacting pin drive which minimizes damage in stop / start applications and viscous fluids
- Bi-metal CDSA™ option also includes Exotic Alloy wetted components at minimum price premium for use with corrosive chemicals
- Sizes available from 1.000" to 5.000" (24mm - 125mm) in standard and ANSI Plus gland formats larger sizes up to 12.000" (300mm) available on request

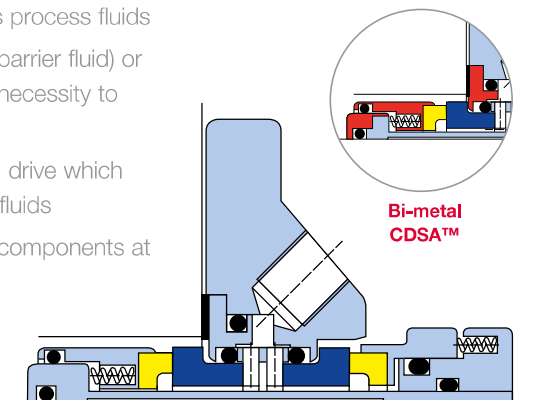

### CDFI™ / CDFC™ — Cartridge Double Flow Induction / Convection

- Integral deflector guides barrier fluid under faces and extends seal life
- Incorporates highly effective bi-directional pumping ring to maximize barrier flow and increase seal life
- Bi-metal CDFI™ / CDFC™ options also include Exotic Alloy wetted components at minimum price premium for use with corrosive chemicals
- Sizes available from 1.125" to 5.000" (28mm - 125mm) in standard and ANSI Plus gland formats

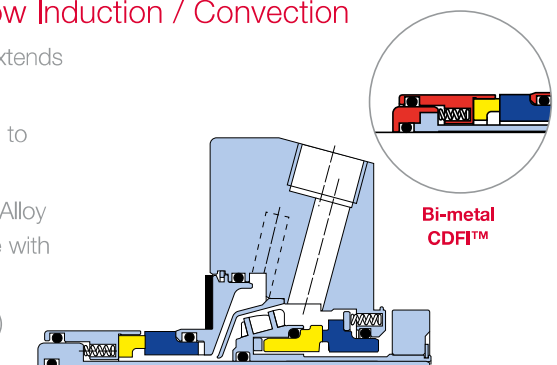

For more information please see the product literature or visit:  
[www.aesseal.com/double](http://www.aesseal.com/double)



CSS/CDP/A



CDSA



CDFI/CDFC



## Double Cartridge Stationary Seals

All the following feature:

- Hydraulically double balanced seal-face technology for reduced power consumption with the ability to withstand pressure fluctuations
- Non-shaft-fretting sleeve elastomer and positive set screw shaft drive
- Independent seal-face design to enhance safe containment of process fluid in the event of damage to any individual sealing element
- Multiple spring seal-face loading with hydraulic pressure balanced for improved reliability and seal performance
- Stationary design is suitable for high speed applications

### DISP™ — Double Stationary Seal with Flow Inducer



- Efficient bi-directional pumping circulates barrier fluid for effective seal-face cooling and extended seal life
- High-integrity drive design features improve reliability and seal life
- Thin radial faces reduce heat generation compared to alternative dual balanced designs
- Supplied with Quench, Flush and Drain ports
- Sizes available from 1.000" to 3.375" (24mm - 85mm) in standard and ANSI Plus gland formats

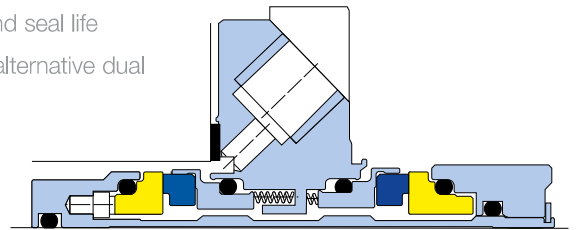

### DMSF™ / DMSC™ — Double Monolithic Stationary Flow / Convection



- Monolithic seal-faces provide maximum face stability in high temperature applications improving seal life
- Seal-face drive over large contact area prevents damage to faces in stop / start applications and viscous fluids
- Incorporates a highly effective bi-directional pumping scroll to maximize cooling and increase seal life
- Large 3/8" NPT seal gland ports maximize cooling potential and extend seal life
- Integral deflector guides cooling barrier fluid to the most essential areas and extends seal life
- Sizes available from 1.000" to 5.000" (24mm - 125mm) in standard and ANSI Plus gland formats

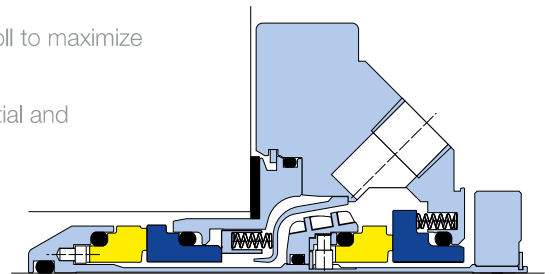

### Exotic DMSF™ / DMSC™

- Exotic DMSF™ / DMSC™ option also includes Exotic Alloy wetted components at minimum price premium for use with corrosive chemicals
- Sizes available from 1.000" to 5.000" (24mm - 125mm) in standard and ANSI Plus gland formats

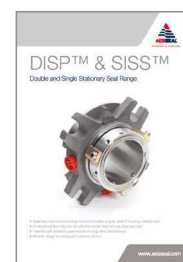
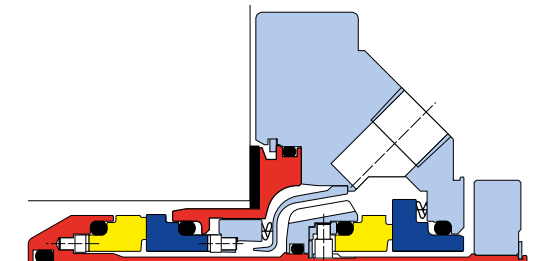

DISP&SISS



DMSF

For more information please see the product literature or visit:  
[www.aesseal.com/double](http://www.aesseal.com/double)

## Progressive Cavity Pump Seals

### PCPS™ Range – Progressive Cavity Pump Seals

Over 1,500 PCP designs available to suit all major PCP manufacturers including Mono, Robbins & Myers, Netzsch, PCM, Seepex, Orbit and many more.

- Available in single or double seal options
- No pump modification necessary, reducing cost of conversion
- Components are modular to standardize seal ranges
- Big bore flared housing maximizes cooling and lubrication, increasing seal life and prevents clogging

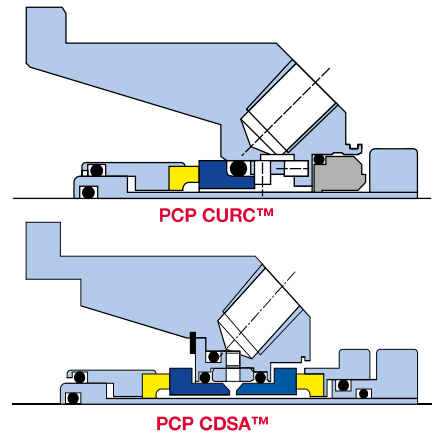

## Non-Metallic Seals for Chemical Pumps

- Non-metallic wetted components in Silicon Carbide for use with corrosive chemicals
- Non-shaft-fretting design to reduce cost in equipment overhaul
- Cartridge design for ease of installation
- Hydraulically balanced seal-faces
- Incorporates pumping ring to maximize cooling and increase seal life with a directed barrier fluid flow path to both sets of seal-faces

### FI-DSNM-R™ — Non-Metallic Cartridge Seal

The FI-DSNM-R™ is designed to suit the Richter (ITT-Goulds), PCK and SCK non-metallic process pumps. This unique cartridge design eliminates the OEM ceramic sleeve.

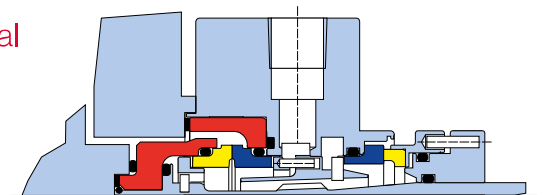

### LSEAL™ — Non-Metallic Cartridge Seal

The LSEAL™ is designed to suit the Flowserve Polychem 'L' series, Group I and Group II non-metallic process pumps. This unique cartridge design simplifies installation and impeller adjustment.

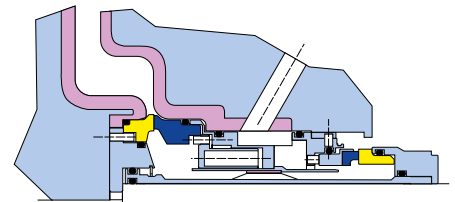

### DSNM™ and FI-DSNM™ — Non-Metallic Cartridge Seals

The DSNM™ is designed to suit the Flowserve Polychem 'S' series non-metallic process pump.

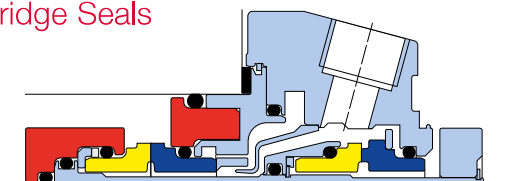

For more information please see the product literature or visit:  
[www.aesseal.com/seals](http://www.aesseal.com/seals)

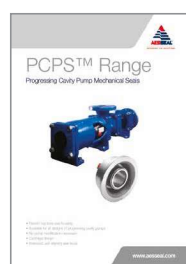

PCP



FIDSNMR



LSEAL



CHEMPROC

## Radially Divided Seals

### RDS™ — Radially Divided Seal

The RDS™ eliminates the need to remove or strip equipment for seal replacement. The unique design makes it the quickest to install two part seal currently available in the market place.

- Precision lapped rotary seal-face provides industry leading separation technology and predictable sealing
- External wear indicator assists preventative maintenance
- Hydraulically balanced seal-faces for reduced seal-face loading, maximizing seal life and allowing for vacuum service capability
- Minimum parts to assemble
- Self-aligning stationary face
- Sizes available from 2.500" to 12.000" (63mm - 300mm)

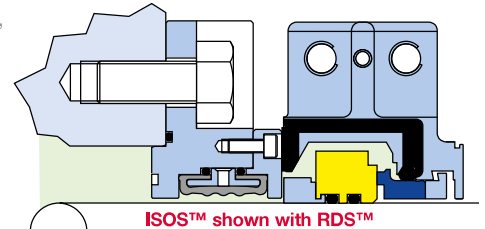

### ISOS™ — Inflation Shut-Off Seal

- Eliminates the need for pump or mixer shut-off valves when changing a seal
- Fitted between the pump and seal it allows quicker and easier changing of the mechanical seal with no need to drain equipment

## Submersible Pump Seals

AESSEAL® has a wide range of seals to suit many submersible pumps from manufacturers including: Flygt®, Grindex®, Emu, ABS, Sarlin, Hidrostal and many more.



SAIH™ to suit Hidrostal

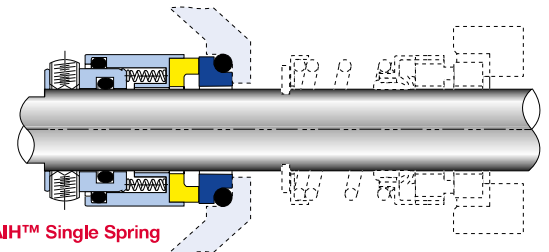

SAIH™ Single Spring

### T05™ Series — Replacement Seals to suit Flygt® and Grindex® Pumps

- Easy to install because it is pre-set
- No pump modifications necessary
- No special fitting tools required
- No plastic parts
- Stainless steel metal parts
- Many seals in the range utilize monolithic seal-faces
- Significant cost savings possible

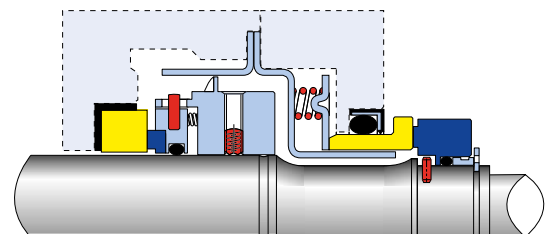

### T05VC™ Series — Replacement Seals to suit Flygt® and Grindex® Pumps

- Easily installed, unitized plug in double mechanical seal
- No pump modifications necessary
- Stainless steel metal construction (no plastic parts)
- Robust design
- Competitive pricing
- Easy to disassemble and re-assemble
- Non-shaft-fretting design

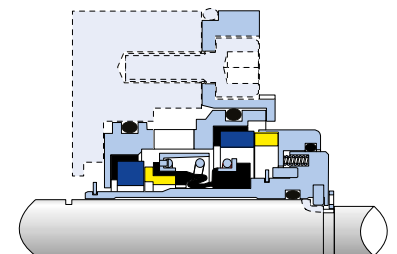

RDS

T05SERIES

For more information please see the product literature or visit:  
[www.aesseal.com/seals](http://www.aesseal.com/seals)

## Metal Bellows Seals

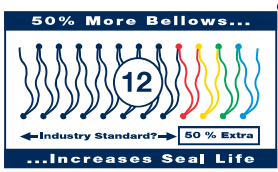

With 50% more bellows than the industry standard (12 instead of 8) there is less stress on each convolution in the bellows stack which helps increase seal life. AESSEAL® standard bellows material, Alloy 276, has superior mechanical and corrosion resistance properties than other industry standard bellows materials such as 300 series Stainless Steel or Alloy 20. The hydraulically balanced bellows unit is available in a variety of different material options with either elastomer or graphite packing sealing rings.

### BSAI™ and BSAIG™ — Bellows Component Seals



- Short working length suitable for BS EN 12756 (formerly DIN 24960) housings
- Suitable for limited space applications
- Hydraulically balanced for reduced seal-face loading which maximizes seal life and allows for vacuum service capability
- Sizes available from 1.000" to 5.000" (24mm to 125mm)

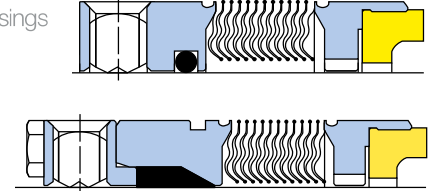

### BQFD™, BQFD-R™ and BSIV-N™ — Bellows Single Cartridge Seals



- Cartridge design for reliable installation
- Hydraulically balanced for reduced seal-face loading which maximizes seal life and allows for vacuum service capability
- The BQFD™ range has Quench, Flush and Drain ports with optional restriction bush (BQFD-R™)
- BQFD™ sizes available from 1.000" to 5.000" (24mm to 125mm)
- BSIV-N™ sizes available from 1.000" to 3.500" (24mm to 85mm) in standard and ANSI Plus gland formats - larger sizes termed BSIV™

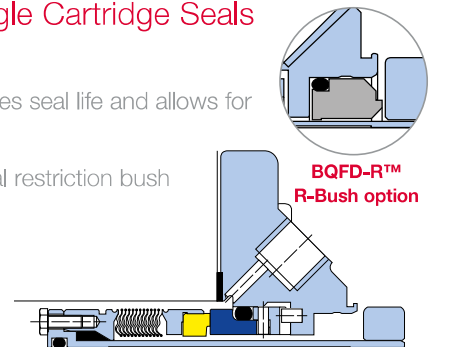

### BSFG™ — Bellows Single Full Graphite Cartridge Seal



- Full graphite seal for high temperature or corrosive chemical applications
- Fits pumps with thin radial seal chamber cross-sections
- Quench, Flush and Drain ports for cooling or heating options to maximize seal life
- Cartridge design for ease of installation
- Sizes available from 1.000" to 4.000" (24mm to 100mm) in standard and ANSI Plus gland formats

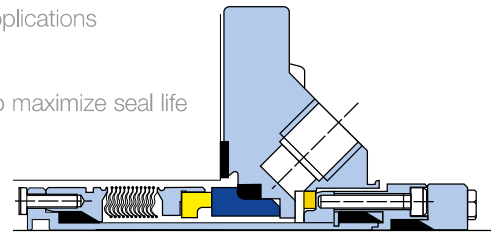

### BDFI™ / BDTP™ — Bellows Double Flow Induced Designs



- Incorporates pumping ring to maximize cooling and increase seal life
- Large 3/8" ports maximize cooling and extend seal life
- Integral deflector guides cooling barrier fluid to the most essential areas and extends seal life
- Sizes available from 1.000" to 5.000" (24mm to 125mm) in standard and ANSI Plus gland formats
- BDTP™ (not shown) is a double cartridge seal with metal bellows inboard and outboard

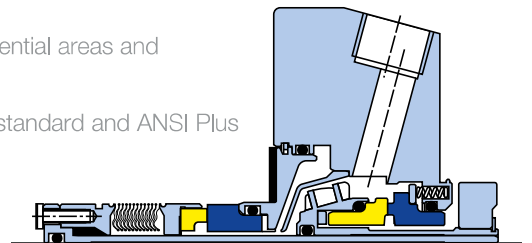

BSAI



BQFD



BSFG



BDFI/BDFC

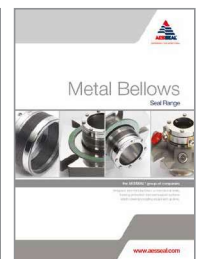

BELLOWS

For more information please see the product literature or visit: [www.aesseal.com/bellows](http://www.aesseal.com/bellows)

## Seals for Mixers, Agitators and Reactors

AESSEAL® offers a complete product range to seal Mixers, Agitators and Reactors.

- Hydraulically balanced for reduced seal-face loading which maximizes seal life and allows for vacuum service capability
- Unitized design for ease of installation
- Non-fretting-design to reduce cost in equipment overhaul
- Modular designs for improved versatility



### ESM™ Range — External Seal For Mixers

- Flange manufactured to suit OEM dimensions
- Collet drive option available for soft or hard shafts
- Sizes available from 1.000" to 2.625" (25mm - 65mm) for other sizes please contact AESSEAL®

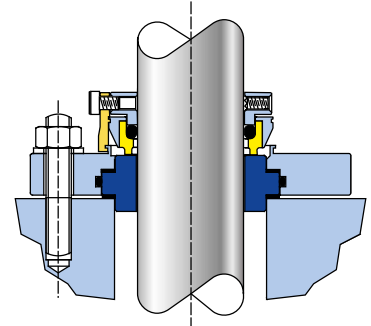

### CSM™ — Cartridge Single for Mixers

- Single cartridge seal
- Can accept radial movement up to 0.062" (1.5mm)
- Can be used on mixers with long overhanging shafts
- Suitable for top entry agitator service and vapour applications
- Exotic alloy wetted parts available for use with corrosive chemicals
- Sizes available from 1.000" to 5.000" (24mm - 125mm) in standard and ANSI Plus gland formats larger sizes up to 12.000" (300mm) available on request

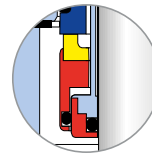

Exotic Alloy Option

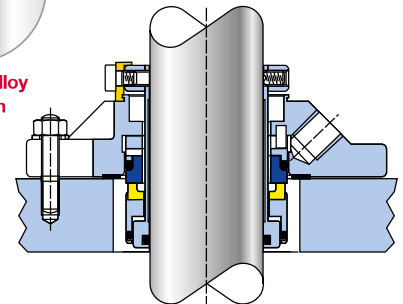

### CDM™ — Cartridge Double for Mixers

- Dual cartridge seal
- Can be used on mixers with long overhanging shafts
- Can accept radial movement up to 0.062" (1.5mm)
- Exotic alloy wetted parts available for use with corrosive chemicals
- Sizes available from 1.000" to 5.000" (24mm - 125mm) in standard and ANSI Plus gland formats larger sizes up to 12.000" (300mm) available on request

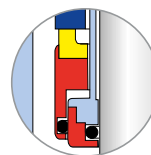

Exotic Alloy Option

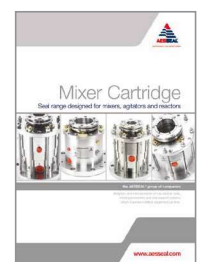
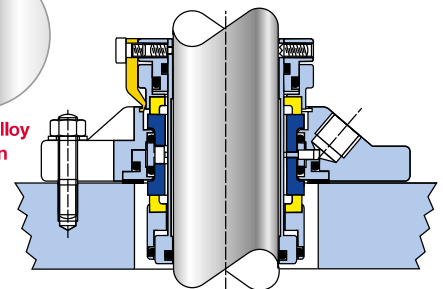

For more information please see the product literature or visit:  
[www.aesseal.com/mixer](http://www.aesseal.com/mixer)

MIXER

# Seals for Mixers, Agitators and Reactors

## CDMSC™ — Canister Double Monolithic Stationary Convection



- Monolithic seal-faces provide maximum face stability in high pressure and high temperature applications improving seal life
- Large contact area of seal-face drive prevents damage to faces in stop / start applications and viscous fluids
- Large internal clearances to maximize seal cooling or heating, extending seal life
- Can accept greater radial movement than many competitor seals
- Offered with an integral cooling or heating jacket which improves the seal environment and extends seal life
- Sizes available from 1.250" to 8.000" (30mm - 200mm)

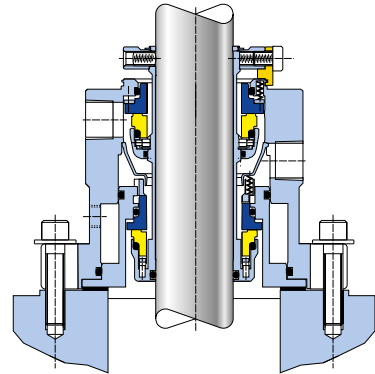

## CSWIB™ (Mixmaster I™)

CSWIB-Cartridge Single with Integral Bearing

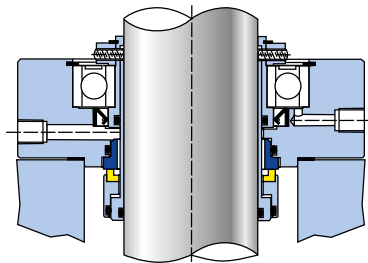

- Designed for agitators and mixers
- Fitted with an integral bearing to stabilize shaft and seal-faces
- Ideal for use on mixers with long overhanging shafts
- Quench and Drain ports can provide cooling or heating to maximize seal life in arduous applications

## DSWIB™ (Mixmaster II™)

DSWIB-Double Seal with Integral Bearing

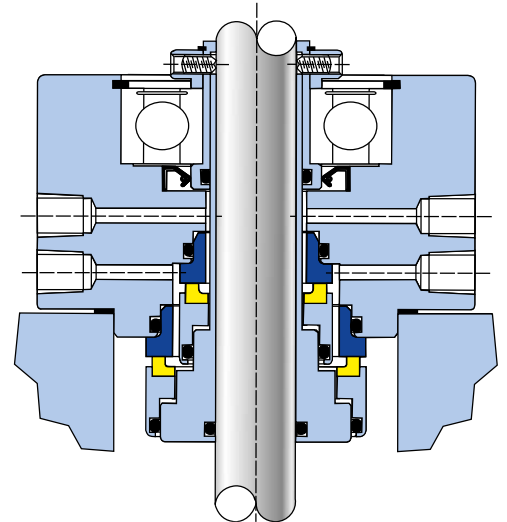

## Mixmaster IV™ — Range of Cartridge Seals for Mixers



- Can be used on mixers with long overhanging shafts and suitable for top entry agitator services
- Available with or without load-carrying bearing to DIN 28-138 parts 1 and 2
- Hydraulically reverse-balanced for reduced seal-face loading to maximize seal life and allow for vacuum service capability
- Non-fretting-design to reduce cost of equipment overhaul
- Available in a wide range of flange designs
- All sizes available from 1.000" to 10.250" (24mm - 260mm)

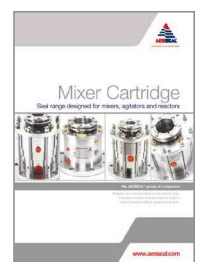
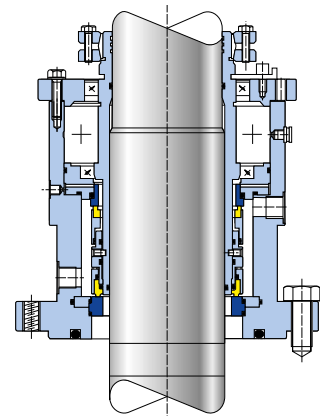

For more information please see the product literature or visit:  
[www.aesseal.com/mixer](http://www.aesseal.com/mixer)

CDMSC

MIXER

# Seals for Mixers, Agitators and Reactors

## Mixmaster V™ and VI™ — Range of Cartridge Seals for Mixers

- Can be used on mixers with long overhanging shafts and suitable for top entry agitator services
- Offered with and without load-carrying bearing to DIN 28-138 parts 1 and 2
- Available with exotic alloy and non-metallic wetted parts for applications with corrosive chemicals
- Hydraulically reverse-balanced for reduced seal-face loading to maximize seal life and allow for vacuum service capability
- Non-fretting-design to reduce cost of equipment overhaul
- Available in a wide range of flange designs (shown right)
- All sizes available from 1.000" to 10.250" (24mm - 260mm)

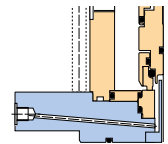

Standard Mixmaster VI™ with Debris Flange

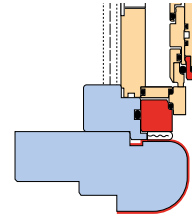
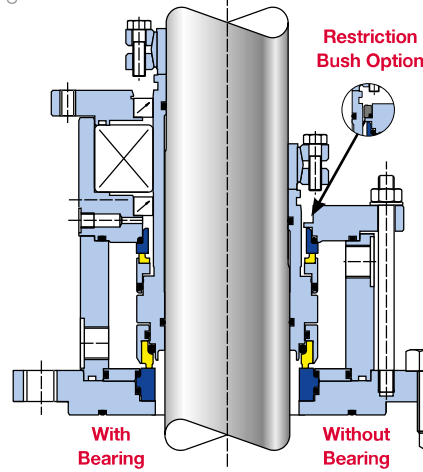

Non-Metallic Flange

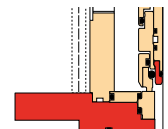

Exotic Alloy Flange

## Mixmaster VII™ — Range of Dry Running Cartridge Seals

- Designed for use with gas barrier systems
- Contact seal-face technology for low gas consumption and high sealing integrity
- Available with or without load-carrying bearing to DIN 28-138 parts 1 and 2
- Available with exotic alloy and non-metallic wetted parts for applications with corrosive chemicals
- Non-fretting-design to reduce cost in equipment overhaul
- Available in a wide range of flange designs (shown above right)
- Inboard and outboard stationary seal-face cooling option available (see below)
- All sizes available from 1.000" to 10.250" (24mm - 260mm)

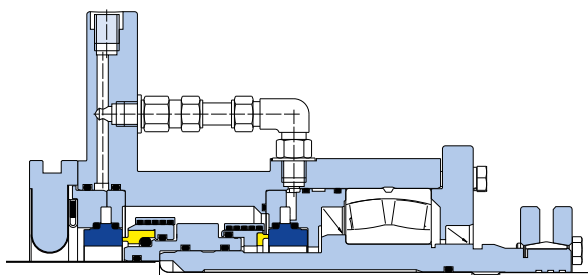
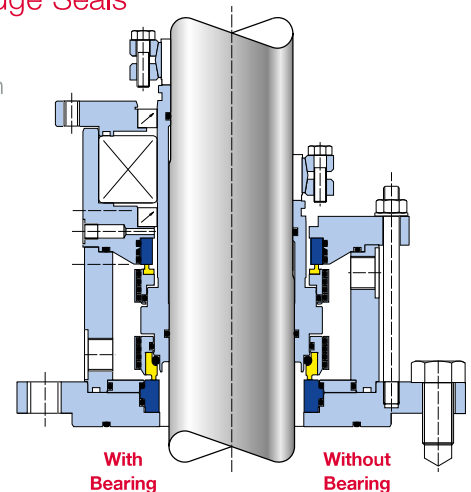

Mixmaster VII-DD™ — Inboard and outboard cooled stationary seat option

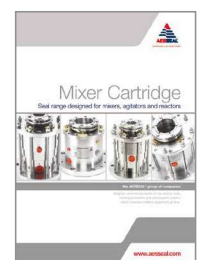
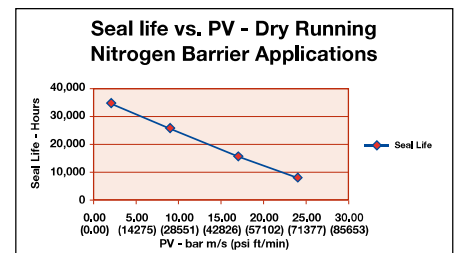

For more information please see the product literature or visit: [www.aesseal.com/mixer](http://www.aesseal.com/mixer)

MIXER

## Oil, Gas and Petrochemical Seals

Having supplied the Hydrocarbon processing and associated industry sectors since the early 1990s, AESSEAL® has a proven track record of extending equipment life, reducing expenditure on seals and optimizing inventory levels for customers in 104 countries.

### CAPI™ Type A, B and C Category I Single and Dual Seals

- Employs qualification tested API 682 technology
- Thin cross-section (TXS) seal designs for mature asset installation, including API 610, 5th Ed. with a 0.500" (12mm) radial cross-sectional space between the shaft and seal chamber
- Robust and reliable seal-face drive (Patented Floating Drive Technology) reduces high-stress points at equipment start-up
- Probably the most compact single and dual API cartridge seals on the market which employ API 682 qualified technology
- All sizes available from 1.000" to 5.000" (24mm - 125mm)

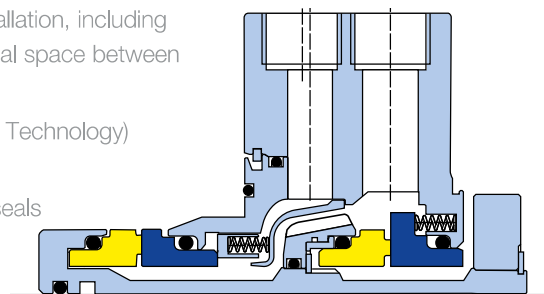

AESSEAL® CAPI-TXS™ Type A Dual Seal

### CAPI™ Type A Category II and III Single and Dual Seals

- Qualification tested to API 682
- Stationary flexible element offered as standard for improved pusher design performance as outlined in API 682 Section 6.1.1.5. Rotary design is available on request
- Multi-port Flush design offered as standard for optimum seal-face cooling
- World-leading bi-directional pumping ring performance with 0.062" (1.5mm) radial clearance between rotor and stator; conforming with API 682 Section 8.6.2.3 **without compromise**
- All sizes available from 0.750" to 4.375" (20mm - 110mm)

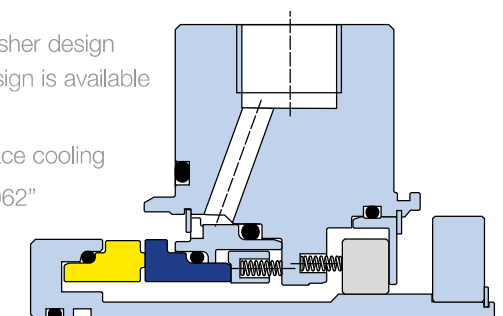

AESSEAL® CAPI™ Type A Single Seal

### CAPI™ Type B Category II and III Single and Dual Seals

- Qualification tested to API 682
- Effective seal-face heat dissipation achieved by a directed barrier fluid flow path, irrespective of shaft rotational direction
- Multi-port Flush design offered as standard for optimum seal-face cooling
- 12 edge-welded bellows convolutions as standard
- All sizes available from 0.750" to 4.375" (20mm - 110mm)

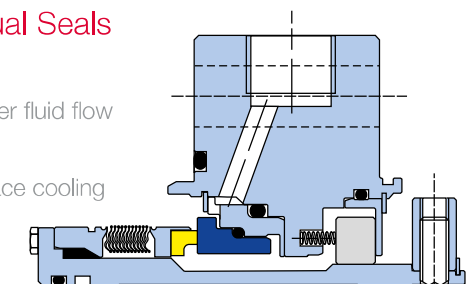

AESSEAL® CAPI™ Type B Single Seal

#### Bellows Convolution Materials:

Alloy 718, AM350 and Alloy 276 as standard

#### Seal-Face Holder Materials:

Alloy 42, Alloy 625, 316L S/S and Alloy 276 as standard

For more information please see the product literature or visit: [www.aesseal.com/seals](http://www.aesseal.com/seals)

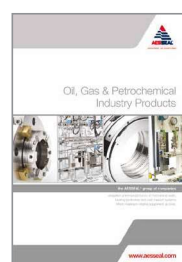

CAPI MAIN



PIPING PLAN



# Oil, Gas and Petrochemical Seals

## CAPI™ Type C Single and Dual Seals

- Qualification tested to API 682
- World-leading bi-directional pumping ring performance with 0.062" (1.5mm) clearance between rotor and stator, conforming with API 682 Section 8.6.2.3 **without compromise**
- Effective seal-face heat dissipation achieved by directed barrier fluid flow path in both single and dual designs
- Segmented floating containment bush operates on a hard plated cartridge sleeve as standard (single seal)
- Identical seal-face technology employed at the inboard and outboard positions (dual seal)
- All sizes available from 0.750" to 4.375" (20mm - 110mm)

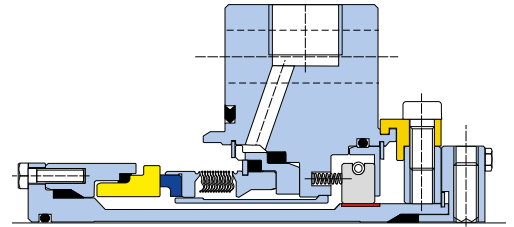

**AESSEAL® CAPI™ Type C Single Seal**

## CAPI™ Containment Seals

- Containment seal technology that exceeds the requirements of API 682 Ed 3, Section 4.2 and ISO 21049
- High heat dissipation properties due to the AESSEAL® close-coupled technology supplied in a robust, short working length pusher design
- Eliminates the need for liquid barrier systems
- Isolation bushing available
- Modular design to all Type A, B and C configurations
- Contacting and non-contacting design
- Bi-directional option available
- All sizes available from 0.750" to 3.625" (20mm - 90mm)  
larger sizes available on application

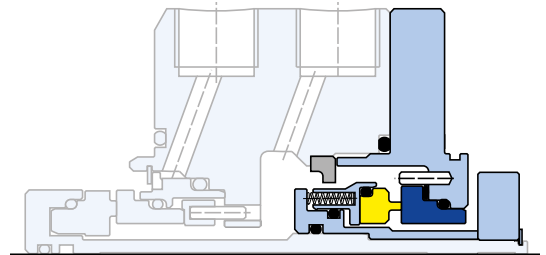

**AESSEAL® CAPI™ Type A Containment Seal**

## High Pressure Seals

### CFC™ / HPVS™ and CFFC™ / HPVD™

These robust seals are designed for use on difficult applications including oil pipeline pumping, water injection and boiler feed duties.

- High speeds – Stationary multi-spring design for even face loading
- High pressures – Robust seal-faces minimize the effects of pressure distortion
- Monolithic seal-faces – maintain flatness under temperature fluctuations
- Axial displacement capacity to accommodate machine build tolerance and differential thermal expansion
- Seal-face design optimized using FEA and hydrodynamic algorithms
- Seal-face loading factory set and statically tested prior to despatch
- Sculpted lug drive – for improved torque transmission
- Compact and robust design – allows seal to be fitted on close bearing centre pumps

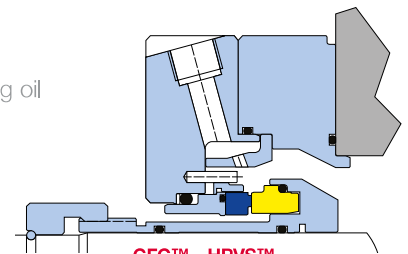

**CFC™ - HPVS™**

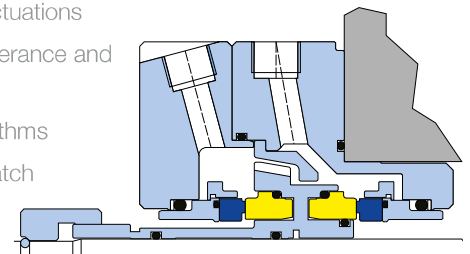

**CFFC™ - HPVD™**

For more information please see the product literature or visit:  
[www.aesseal.com/seals](http://www.aesseal.com/seals)

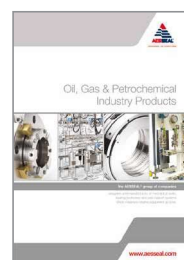

**CAPI™**



**PIPINGPLAN**

## Pump Dry Gas Seals

The advantages of sealing pumps with dual pressurised dry gas seals are becoming widely recognized throughout industry. AESSEAL® has developed a range of pump dry gas seals to suit every application.

### UDGS™ — Universal Dry Gas Seal for Pumps



- Non-contacting spiral groove face technology
- Long life with low power consumption
- Externally mounted and suitable for ISO 5199 and ANSI pumps
- Can be adapted to fit other types of rotating equipment
- **Zero** process emissions
- Low running costs

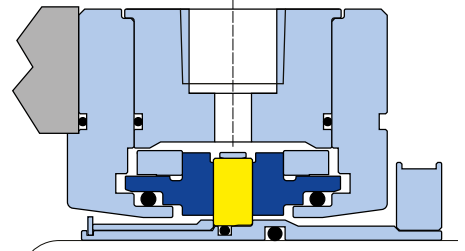

### CAP74™ — Face-to-Face Dual Pressurised Dry Gas Seal for Pumps



- A non-contacting seal primarily designed for API 610 pumps which require seals to API 682 standard
- Non-contacting spiral groove face technology
- Bi-directional option available
- **Zero** process emissions
- Low running costs
- Specially engineered variants available on request

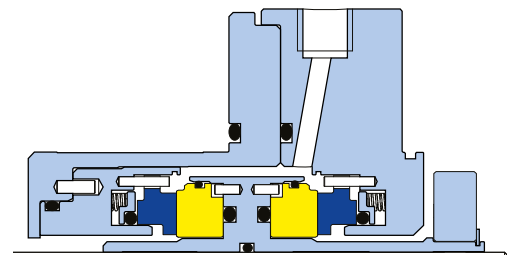

Bi-directional



Uni-directional

### Mixer Gas Seal



- Incorporates non-contacting seal-face technology with low gas consumption and high sealing integrity
- Available with exotic alloy wetted parts for applications with corrosive chemicals
- Non-fretting-design to reduce cost in equipment overhaul
- Outboard stationary seal-face cooling option available

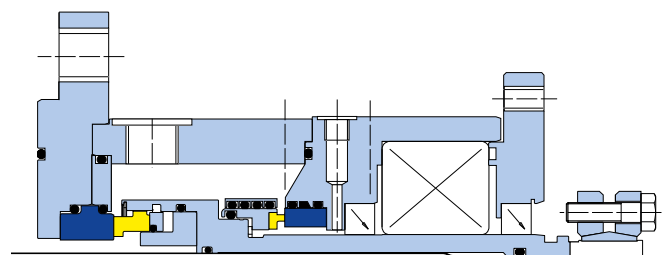

For more information please see the product literature or visit:  
[www.aesseal.com/gas](http://www.aesseal.com/gas)

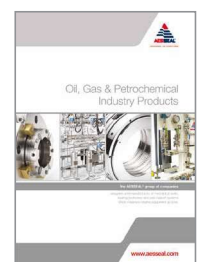

CAPIMAIN

## Compressor Dry Gas Seals

AESSEAL® produces compressor dry gas seals in all configurations, incorporating a number of unique features which combine enhanced performance with increased life.

Both uni-directional and bi-directional designs are available and can be backed up by one of our range of separation seals.



### CCS™ — Conventional Compressor Seal

- Supplied in 410 stainless steel as standard with exotic alloy options on request
- Available with Silicon Carbide seats as standard. Tungsten Carbide and Silicon Nitride seats available on request. Mating faces available in Carbon and synthetic diamond coated Silicon Carbide
- 'O' ring and spring energized polymer versions available
- Designs available as single, double, tandem or tandem with intermediate labyrinth, for increased integrity
- Fully shrouded seats adopted as standard
- Bi-directional seal designs also available

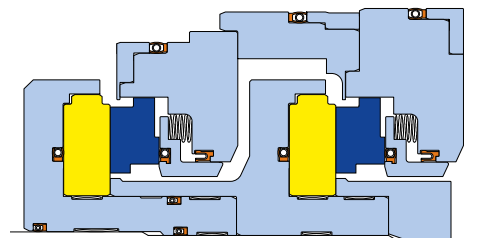

### HHCS™ — Hydrostatic and Hydrodynamic Compressor Seal

- Unique, patented DualDam™ compressor dry gas seal technology offers robust protection for the sealing surfaces during start-up, coastdown, slow roll and upset conditions
- Supplied in 410 stainless steel as standard with exotic alloy options on request
- Available with Silicon Carbide seats as standard. Silicon Nitride seats available on request. Mating faces available in Carbon and synthetic diamond coated Silicon Carbide
- Capable of withstanding unintentional reverse rotation
- 'O' ring and spring energized polymer versions available
- Designs available as tandem or tandem with intermediate labyrinth for increased integrity
- Fully shrouded seats adopted as standard
- Bi-directional seal designs also available

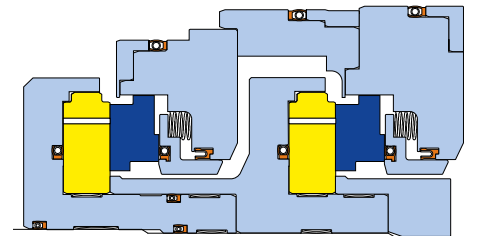

### Compressor Dry Gas Seal Support Systems

High quality compressor dry gas seal support systems engineered to customer requirements for all seal configurations and applications. Each AESSEAL® gas conditioning system contains the key API modules plus various enhancements derived from our own field experience, to ensure the highest degree of compressor dry gas seal reliability and longevity.

For every application AESSEAL® performs a detailed phase analysis in-house to determine the required level of gas conditioning.

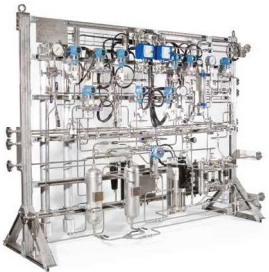

For more information please see the product literature or visit:  
[www.aesseal.com/gas-seal](http://www.aesseal.com/gas-seal)

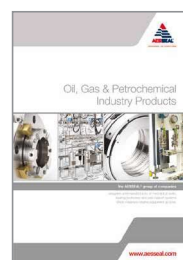

CAPIMAIN



SYSPROD

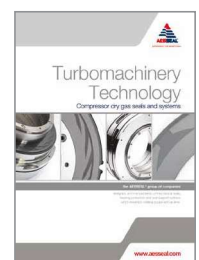

TURBO

## Industry Expertise

Our products are in demand worldwide, and across all industry sectors.

Wherever we supply, the story is the same: our sealing technology delivers increased reliability, demonstrated by increased mean time between failure. Today we are working with an impressive portfolio of customers, in all industry sectors.



### Oil & Gas

Our competitive, and continuing, advantage in this sector comes from offering innovative solutions with measurable value. You'll find more detail about us on our website: [www.aesseal.com/oil-gas](http://www.aesseal.com/oil-gas)



### Power Generation

AESSEAL® is probably the only global seal solution provider who can address all the seal issues in this market. To find out more please visit: [www.aesseal.com/power](http://www.aesseal.com/power)



### Mining & Minerals

AESSEAL® mining solutions are designed to handle the most arduous applications. To find out more please visit: [www.aesseal.com/mining](http://www.aesseal.com/mining)



### Pulp & Paper

AESSEAL® has introduced a range of innovative, patented products to meet the vast range of demands of the pulp and paper and paper-recycling industries. To find out more please visit: [www.aesseal.com/paper](http://www.aesseal.com/paper)



### Chemical & Pharmaceutical

AESSEAL® has developed innovative new sealing solutions to the myriad challenges of these industries. To find out more please visit: [www.aesseal.com/chemical](http://www.aesseal.com/chemical)



### Food & Beverage

AESSEAL® has inventoried solutions to suit many types of equipment found in this industry and has proven expertise in the processes. To find out more please visit: [www.aesseal.com/food](http://www.aesseal.com/food)



### Bio / Ethanol

AESSEAL® is a market-leader in this industry with over 4,000 seal installations and 2,500 system installations. To find out more please visit: [www.aesseal.com/bio-ethanol](http://www.aesseal.com/bio-ethanol)



### Water & Waste Water

AESSEAL® has sealing technology solutions, with proven-reliability, for each stage of the process. To find out more please visit: [www.aesseal.com/water](http://www.aesseal.com/water)



### Metal Processing

AESSEAL® has a range of sealing technologies to increase reliability for all stages of metal processing. To find out more please visit: [www.aesseal.com/metal](http://www.aesseal.com/metal)



### Automotive

AESSEAL® supplies reliable mechanical seal technology and systems that increase uptime of pump equipment to help companies achieve higher quality. To find out more please visit: [www.aesseal.com/automotive](http://www.aesseal.com/automotive)

## Industry Specific Designs

AESSEAL® offers a wide range of products, both standard and standard-plus designs for specific requirements for individual industries. Examples of a few specialist products are shown below.



### CDPH™ — Double Seal for Heavy-Duty Slurries

- Double mechanical seal is designed to meet the arduous requirements of heavy duty slurry applications
- Stationary faces are oversized to allow for more radial movement
- Large ports and increased radial clearances enable the seal to maintain a stable fluid film for extended seal life
- Metal parts are much more heavy duty
- Exotic metal parts are available to resist corrosion and erosion

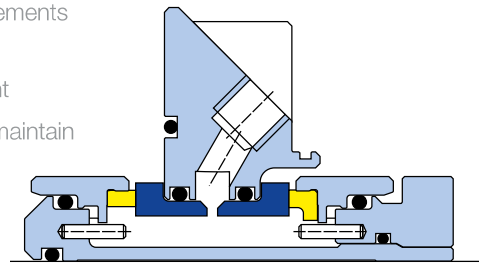

### IASC™ / IADC™ — Single and Double Screen Seals

Standard AESSEAL® screen seals are available to suit many of the popular screen models including Voith, Impco, Hooper, Valmet and Andritz.

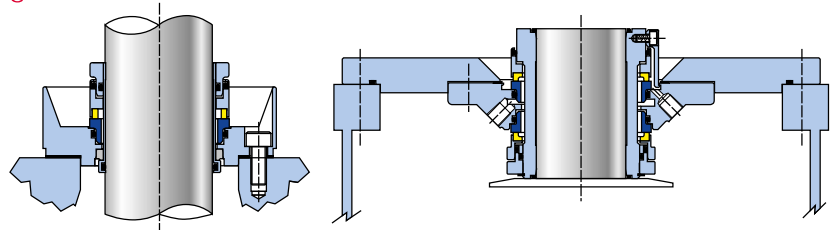

### Many more industry specific product offerings available.

You can find details on all of these brochures on our web site at: [www.aesseal.com](http://www.aesseal.com) or request them from our marketing department by email at: [marketing@aes seal.com](mailto:marketing@aes seal.com)

For more information please see the product literature or visit: [www.aesseal.com/seals](http://www.aesseal.com/seals)

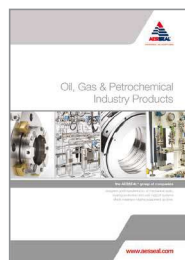

CAPIMAIN

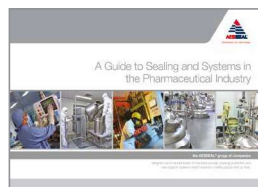

PHARMA

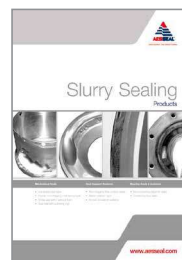

SLURRYPROD

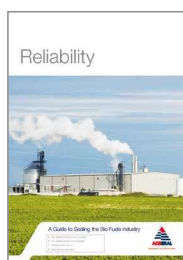

BIOFUELS

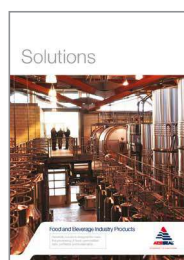

F&B

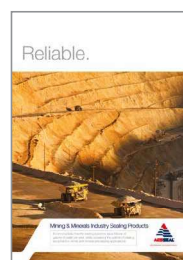

M&M

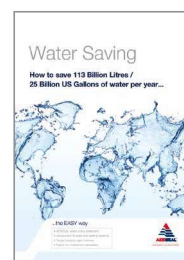

SYSGUIDE

## Bearing Protectors

Eliminate the cause of over 50% of bearing failures with the LabTecta®66 IP66-certified bearing protector.

Recent research\* shows that water and solids contamination causes 52% of bearing failures. Good bearing protection can eliminate these failures.

### LabTecta®66— Labyrinth Bearing Seal



- IP66 Certified (the highest third-party certified bearing protector in the world, as laboratory tested against the Ingress Protection Code)
- Non-contacting Labyrinth Bearing Protector ideally suited for high shaft speed or marginal lubrication applications
- Inexpensive to repair
- Available with full ATEX certification, complying with ATEX directive 94/9/EC (Group II equipment, Categories 2 & 3)
- Sizes available from 0.750" to 12.000" (16mm - 300mm) larger sizes available on request

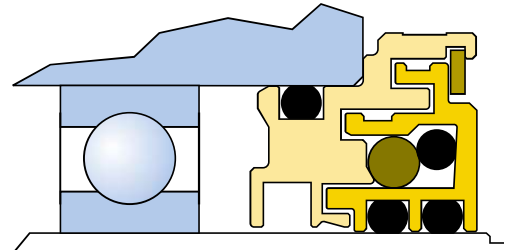

### LabTecta®66TE — Top Entry / Vertical Applications



- Designed for vertical applications
- Shrouded rotary design
- Sizes available from 0.750" to 12.000" (16mm - 300mm) larger sizes available on request

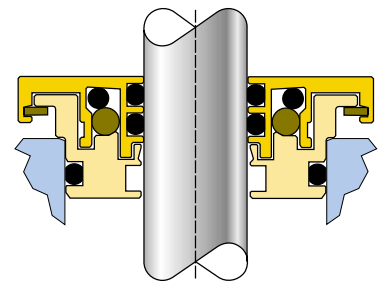

### MagTecta™ — Magnetic Face Seal Design

- Double faces supplied in Carbon / TC for double protection
- Compact housing will fit the majority of lip seal cavities without the need for modification of equipment
- Sizes available from 0.750" to 5.875" (16mm - 145mm) larger sizes 6.000" to 12.000" (150mm - 300mm) also available on request

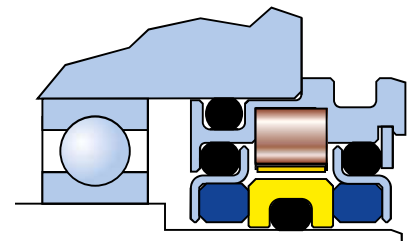

### MagTecta-OM™ — Oil Mist Applications

- Unique oil mist collecting and retainment system for improved seal life
- Sizes available from 0.750" to 5.875" (16mm - 145mm) larger sizes 6.000" to 12.000" (150mm - 300mm) also available on request

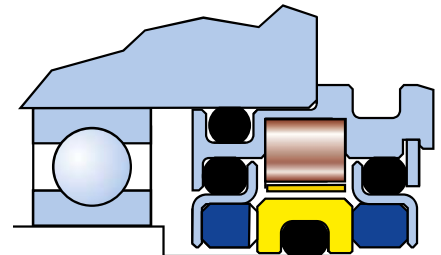

**Designs for Pillow Blocks, axial shaft movement and split seal designs are available on request.**

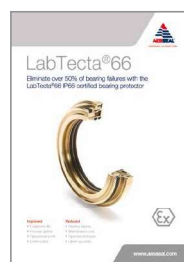

**LABTECTA**



**MAGTECTA**

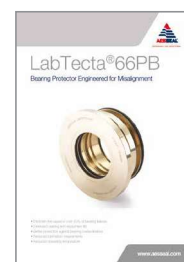

**LABTECTA-PB**



**LABTECTA-AX**

For more information please see the product literature or visit: [www.aesseal.com/bearings](http://www.aesseal.com/bearings)

## Gland Packing

AESSTAR packing range offers high sealability and better compression distribution

Design benefits include low energy consumption, less shaft wear and heat generation, more efficient running, less adjustment and maintenance time.

### Style 266 / 266TP ALLSTAR

- Reduced wear through special running track reinforcement
- Excellent with hardening and crystallising products
- High cross-section density, still elastic and flexible

### Style 275 / 275TP SLURRYSTAR

- e-PTFE / graphite packing with para-Aramid corner protects against abrasives
- Extrusion-resistant packing with improved heat conductivity
- Safe and universal packing for abrasive media

### Style 285 / 285TP PAPERSTAR

- Meta-Aramid fiber packing with PTFE and run-in lubricant
- High cross-section density and structural consistency, elasticity and adaptability
- Impregnation ensures that the packing does not harden, whilst improving flexibility and resisting wear

### Style 366 / 366TP GRAPHOSTAR

- Universal plantwide use in static and dynamic applications
- High temperature resistance, excellent heat transfer rates
- Extrusion stability through carbon corner reinforcement

### Style 380 / 380TP CARBOSTAR

- Volume stable, non shrinking
- Excellent heat transfer when running with higher shaft speeds
- Suitable for medium abrasive products

### Style 770 / 770TP PULPSTAR

- e-PTFE / graphite packing with PTFE corner reinforcement and pore-filler
- Minimal wear allows packing to be used on non-hardened sleeves
- Universal resistance against solvents, acids, caustics and crystallising products

### Style 795 / 795TP UNISTAR

- Very good thermal conductivity
- Does not harden in use allowing easy removal
- Excellent chemical resistance

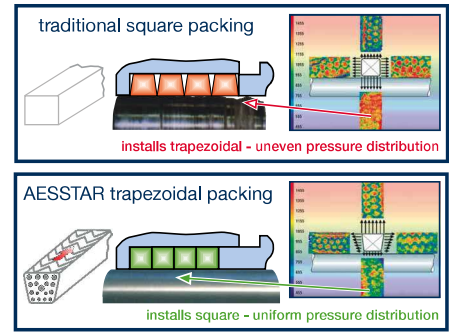

For more information please see the product literature or visit: [www.aesseal.com/packing](http://www.aesseal.com/packing)

**PACKING**

## Seal Support Systems

AESSEAL® offers a wide range of innovative and modular seal support systems to complement its mechanical seal designs. A selection of these is shown below.

There are seal support system solutions available for all of the API Piping Plans. The API Piping Plan book shows standardized flushing piping arrangements that are widely used in the industry. Please contact AESSEAL® Systems Division for further details. Tel: +44 (0)28 9266 9966, Email: [systems@aesseal.com](mailto:systems@aesseal.com)



### SWFF-TF™ — Flow Fuse™ Water Management System

- **Flow-sensing shut-off valve** — Protects the process from barrier fluid contamination upon catastrophic seal failure
- **Water regulator** — Maintains water level and pressure in the vessel
- **Automatic re-set facility** — Protects the mechanical seal from running dry during a process upset
- **Thermal relief valve** — Maintains system pre-set pressure by accommodating any thermal expansion



### SW Range (SW2™ and SW3™) — Water Management Systems

- **10 / 25 litre (2.8 / 6.6 gal US) 304 SS Vessel Construction** — Suitable for a range of challenging environments
- **Water regulator** — Maintains water level and pressure in the vessel
- **Flow indicator** — Visually alerts the user to an inboard seal failure
- **Non-return valve** — Protects plant water supply from contamination, and maintains vessel pressure in the event of supply interruption
- **Available with / without cooling coil** — Additional heat dump available if required



### SP Range (SP1™ - SP3™) — Gas Pressurised Barrier Fluid Systems

- **12 / 25 litre (3.2 / 6.6 gal US) 304 SS vessel construction** — Suitable for a range of challenging environments
- **Integral 304 SS weld pad level gauge** — Robust and industrially acceptable visual indication of fluid level
- **Satin bead blast vessel finish** — Suitable for a wide range of industrial environments
- **Available with / without cooling coil** — Additional heat dump available if required



### FLOWTRUE® — Water Flow Control System

- **Adjustable flow meter** — Controls the amount of water flowing to the mechanical seal for cooling purposes
- **Innovative flow tube cleaning mechanism** — The device can be cleaned without interrupting flow and pressure to the seal
- **Unique segmental valves** — Prevents FlowTrue® from clogging
- **Integrated non-return valve** — Protects plant water supply from product contamination
- **Modular design** — Ensures that the device can be easily upgraded and repaired







## PUMPPAC™ — API Plan 54 Forced Oil Circulation System

- **Forced circulation** — Maximizes heat dump potential for the more arduous applications
- **Back pressure control valve** — Ensures a positive barrier fluid pressure at the seal-faces
- **Modular design** — Allows the PUMPPAC™ to be installed in a variety of zoned environments by interchanging the instrumentation options



## FDU™ — Fluid Distribution Unit

- **Independent pressurised fluid supply system** — Removes the expense of piping a pressurised clean water / oil supply to a new area of the plant
- **Feeds a number of seal support systems** — Removes the expense of purchasing one system per seal
- **Optional pressure switch and accumulator** — Enables greater control of water / oil line pressure
- **Reduced energy consumption** — The system can be operated intermittently to reduce energy costs via dead-ended piping



## AES-28™ — Seal Support System for API 610 and 682 Industries

- **Designed and manufactured in accordance with ASME V III Div 1 and PED 2014/68/EU** — Suitable for a wide range of arduous environments. Design rating of 45 bar @ 100°C / 652.7 psi @ 212°F
- **316 SS vessel and weld pad construction** — Robust vessel suitable for a range of challenging environments
- **28 litre / 7.4 gal (US) vessel** — Large barrier fluid capacity for seal cooling
- **Modular design** — A number of intrinsically safe and EEXD explosion-proof instrumentation option can be fitted



## API Plan 53B

- **Innovative modular manufacturing process** — Guarantees quality product within an exceptional lead time
- **Thousands of man hours dedicated to design and certification** — Ensures product quality and detailed data packages document every aspect of the 53B system
- **AESSEAL® manages every aspect of the manufacturing process** — Welding is carried out to ASME XI specifications



For more information please see the product literature or visit: [www.aesseal.com/systems](http://www.aesseal.com/systems)



SYSPROD



PIPINGPLAN

## Company Overview

AESSEAL® is a leading global specialist in the design and manufacture of mechanical seals, bearing protectors and seal support systems. With operations in six continents, AESSEAL® is the world's 4th largest supplier of mechanical seals, achieving growth through exceptional customer service and innovative products that provide real customer benefits.

For every seal developed by AESSEAL®, we use state-of-the-art computational facilities and numerical tools to design and optimize seal performance prior to manufacture and testing. These tools include Predictive Software Code developed in-house, Finite Element Analysis (FEA) and Computational Fluid Dynamics (CFD). Our numerical tools are used for seal design, performance optimization, special product application and troubleshooting. In combination with an extensive test program the result is world-leading technology that keeps your equipment running longer.

Over 7% of annual sales revenue has been reinvested in R&D over several decades. This has almost certainly led to the most advanced range of sealing technology available globally.



### Environment

- we are BS EN ISO 14001 certified on three continents
- we save in excess of 25 billion US gallons (95 billion litres) of water for customers each year
- our products reduce harmful emissions and energy consumption
- we encourage environmental improvements from our suppliers

### Community

- we promote engineering and other core subjects in local schools and communities
- we mentor students of all ages and abilities
- we actively improve the quality of life for under-privileged and disadvantaged groups
- we promote the use of foreign languages in schools

The AESSEAL UK mechanical seal test facilities are probably the most technically advanced in Europe.

Computer-controlled test bays can be programmed to validate seal designs to any pre-determined cyclic pressure, temperature and shaft speed configuration. Take a three-minute tour by visiting [www.aesseal.com/en/resources/video/journey-a-seal](http://www.aesseal.com/en/resources/video/journey-a-seal)

### Research & Development Test Facilities

- Shaft Speed: Up to 45,000 rpm
- Pressure: Up to 5,000 psig (350 barg)
- Temperature: Up to 536°F (280°C)

- Flashing and Non-Flashing Hydrocarbons
- Caustics, Water and Hot Oil
- Volatile Organic Compounds

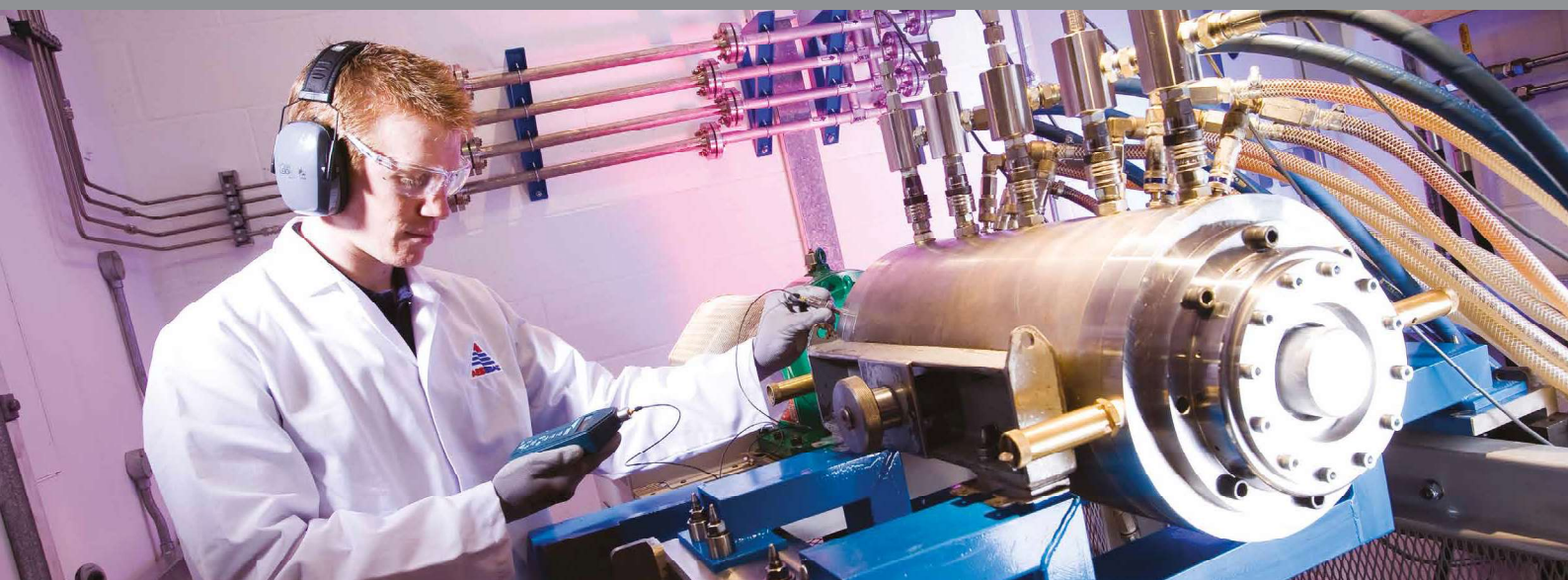
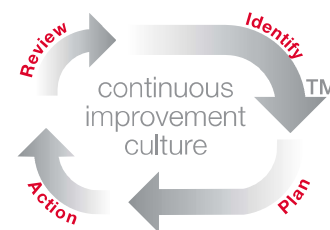

### Ethical

- we reject all types of corruption
- we promote equal opportunities
- we invest in regions of economic deprivation
- we communicate with our stakeholders in their native language

### Health & Safety

- we are OHSAS 18001 certified
- we aim to reduce noise pollution and manual handling operations
- we are committed to the Five S's (sorting, straightening, shining, standardizing, and sustaining)
- we have a company-wide unlimited budget for any safety-related issue



EXPERIENCE THE EXCEPTIONAL

To experience the exceptional, please contact your local representative. Discover full details on our website:

[www.aesseal.com](http://www.aesseal.com)

For further information and safe operating limits contact our technical specialists at the locations below.



Use double mechanical seals with hazardous products.

Always take safety precautions:

- Guard your equipment
- Wear protective clothing



**WARNING**

**UK Sales & Technical advice:**

AESSEAL plc  
Mill Close  
Bradmarsh Business Park  
Rotherham, S60 1BZ  
United Kingdom  
Tel: +44 (0) 1709 369966  
Fax: +44 (0) 1709 720788  
E-mail: [seals@aes seal.com](mailto:seals@aes seal.com)

Distributed by:

'Our purpose is to give our customers such exceptional service that they need never consider alternative sources of supply.'



**USA Sales & Technical advice:**

AESSEAL Inc,  
355 Dunavant Drive  
Rockford,  
TN, 37853  
USA  
Tel: +1 865 531 0192  
Fax: +1 865 531 0571  
E-mail: [usa@aes seal.com](mailto:usa@aes seal.com)

**Important:** Since the conditions and methods of use of this product are beyond our control, AESSEAL plc expressly disclaims any and all liability resulting or arising from any use of this product or reliance on any information contained in this document - AESSEAL plc standard conditions of sale apply. All sizes are subject to manufacturing tolerances. We reserve the right to modify specifications at any time. AESSEAL® is a Registered Trademark of AES Engineering Ltd, AESSEAL plc recognizes all trademarks and trademark names as the property of their owners.

LN-UK/US-PROD-09 Copyright © 2016 AESSEAL plc 09/2016